

x2

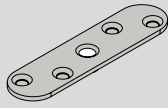

x2

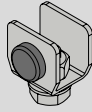

x2



x4

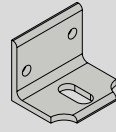

x4

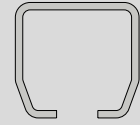

x1



180 lbs

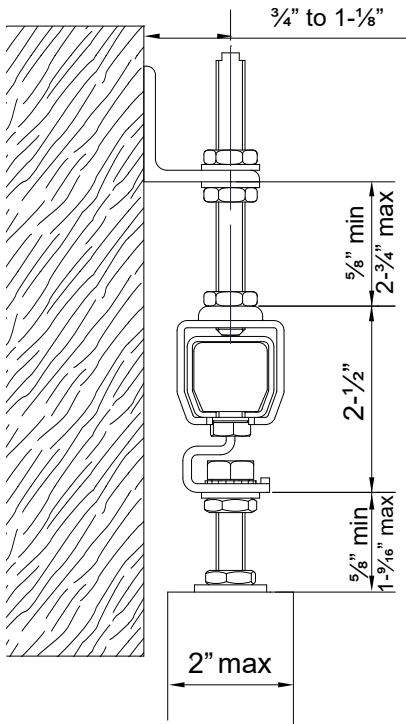

1

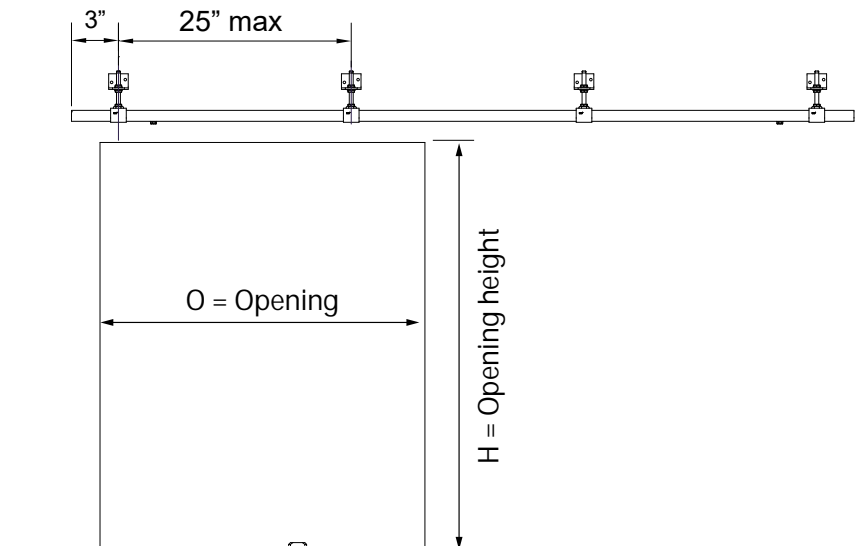

2

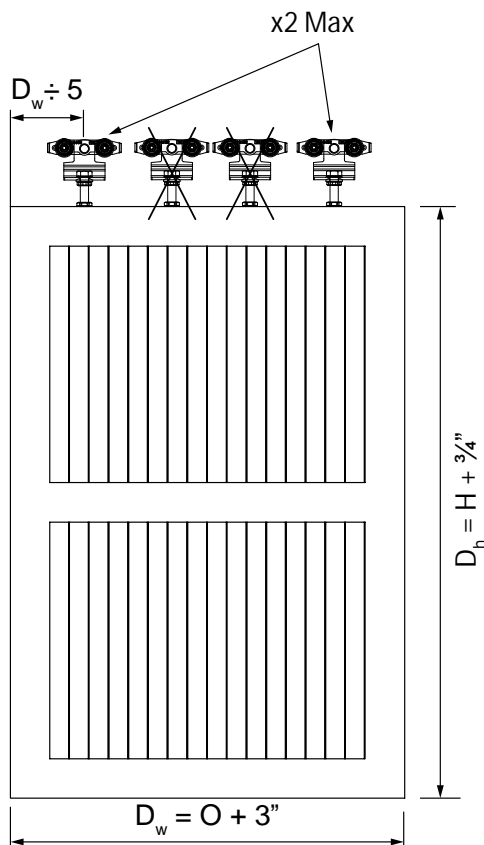

3

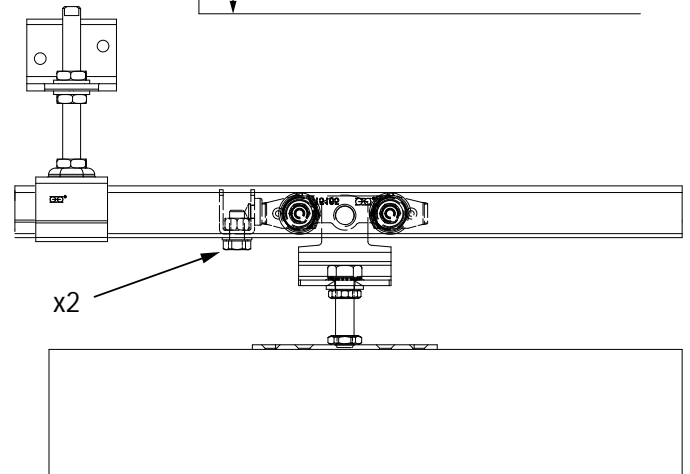

4 OPTION :

