



SLID'UP
BY MANTION

ASSEMBLY
INSTRUCTIONS

SLID'UP 2500

SU2502_NA

Door thickness:
1-3/8" or 1-3/4"

DO NOT THROW
THE PANELS

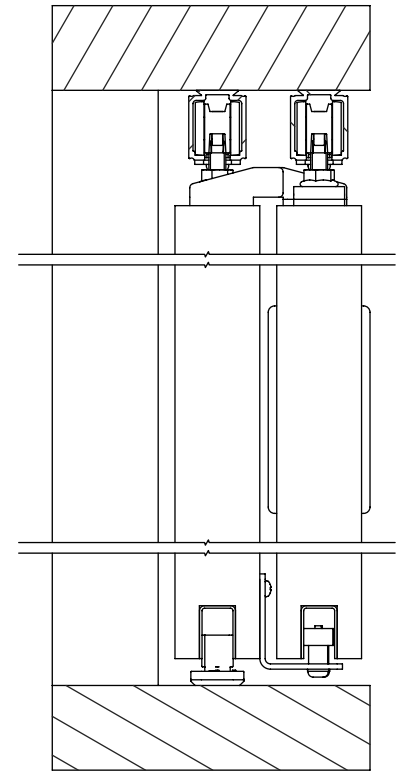
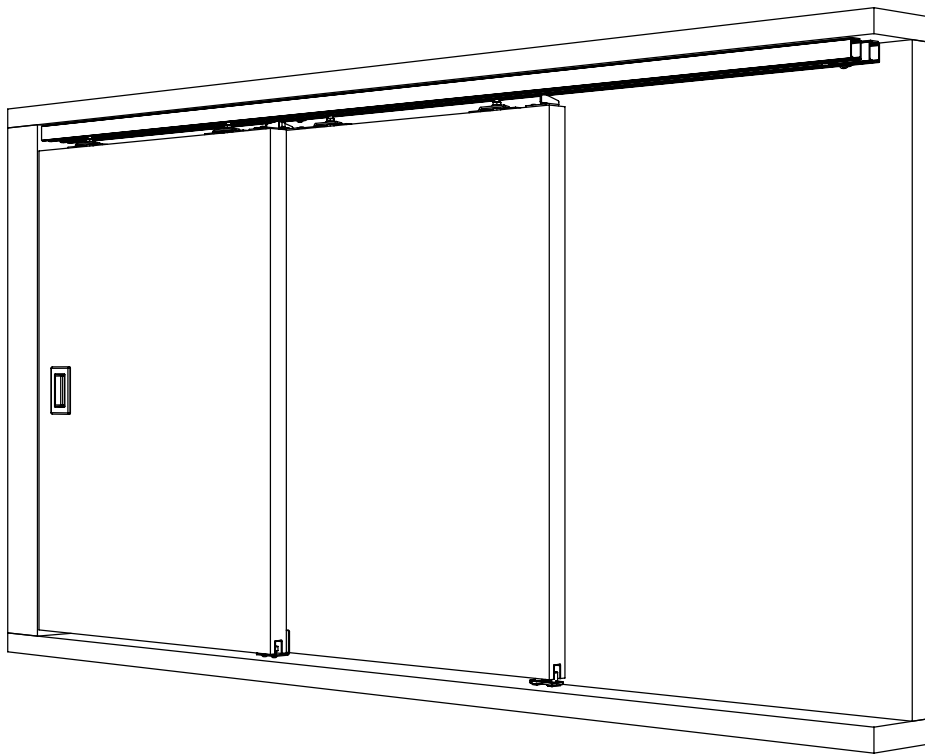
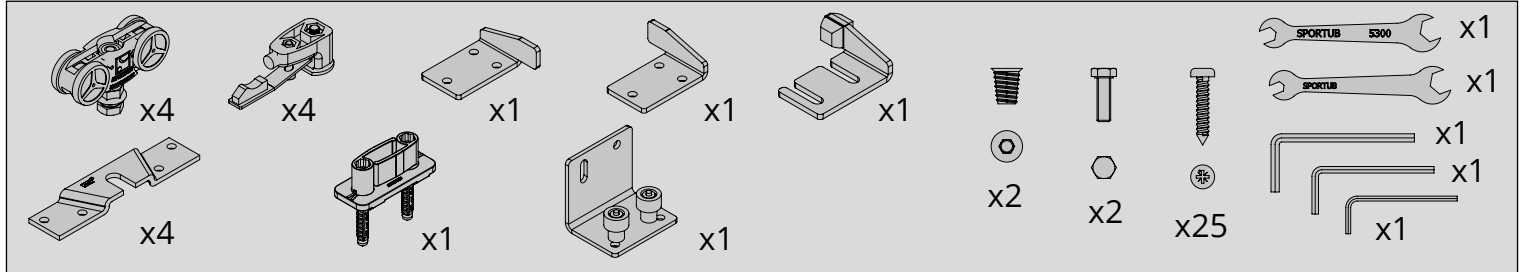

OPTIONS

SU5018

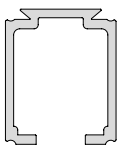

SU5021

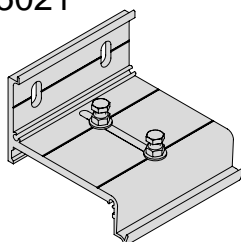

SU5013



SU5022

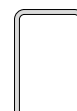

SU1724

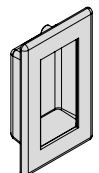

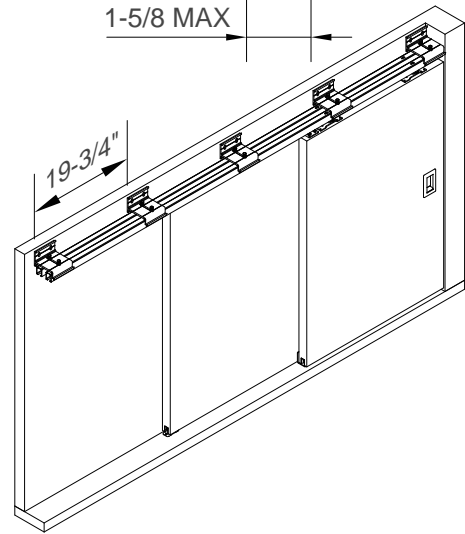
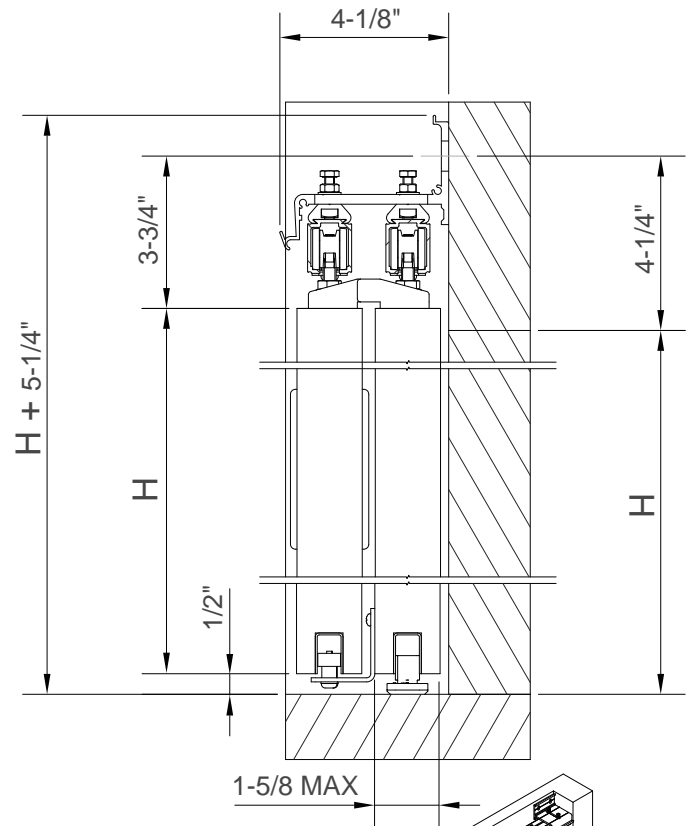
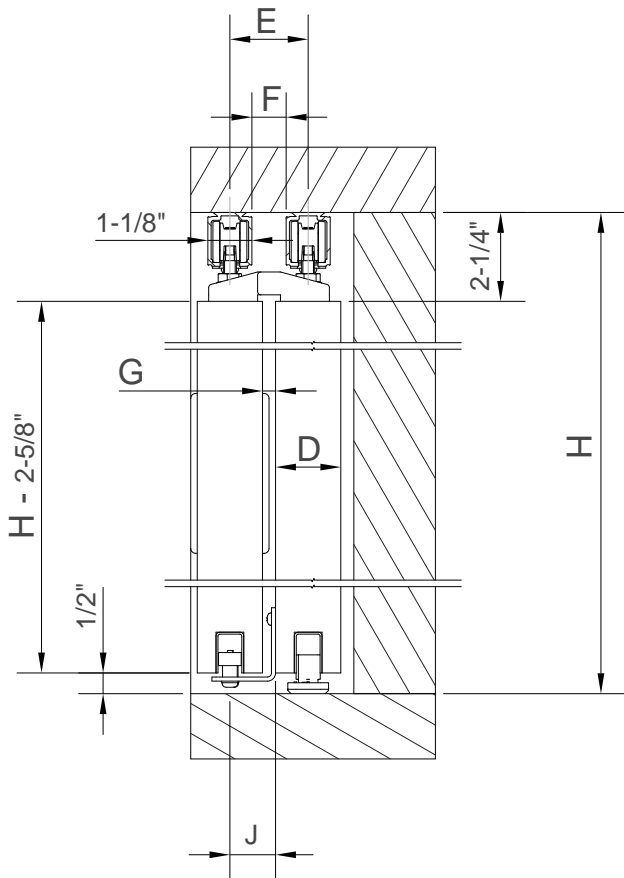

D	E	F	G	J
1-3/8"	1-3/4"	3/4"	3/8"	1-3/32"
1-3/4"	2-1/8"	1-1/16"	3/8"	1-1/4"

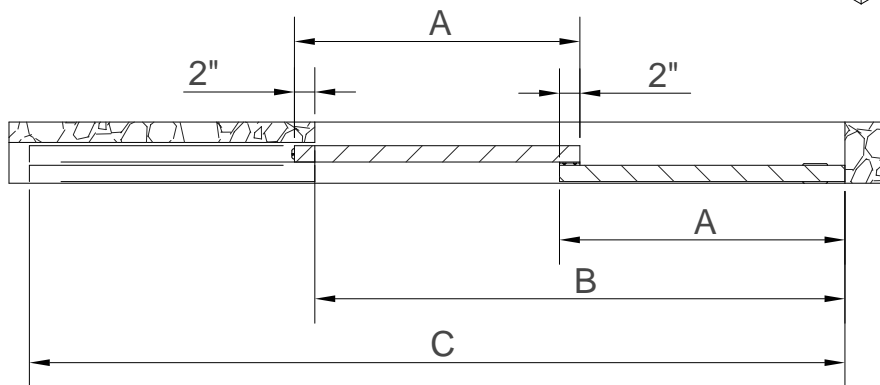

A	B	C
26"	48"	74"
28"	52"	80"
30"	56"	86"
32"	60"	92"
34"	64"	98"
36"	68"	104"

$$A = \frac{B}{2} + 2"$$

$$C = A + B$$





P1

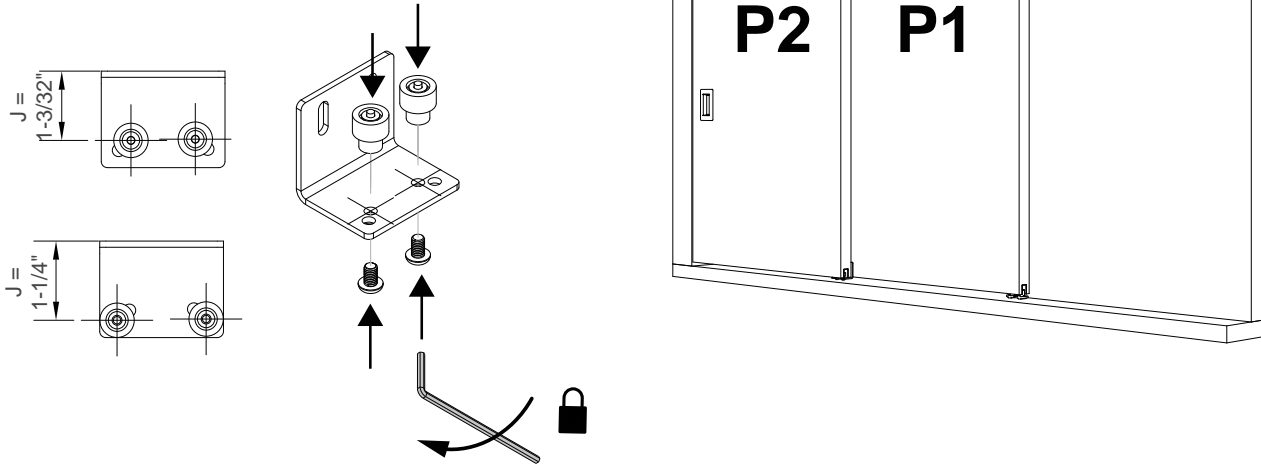

P1

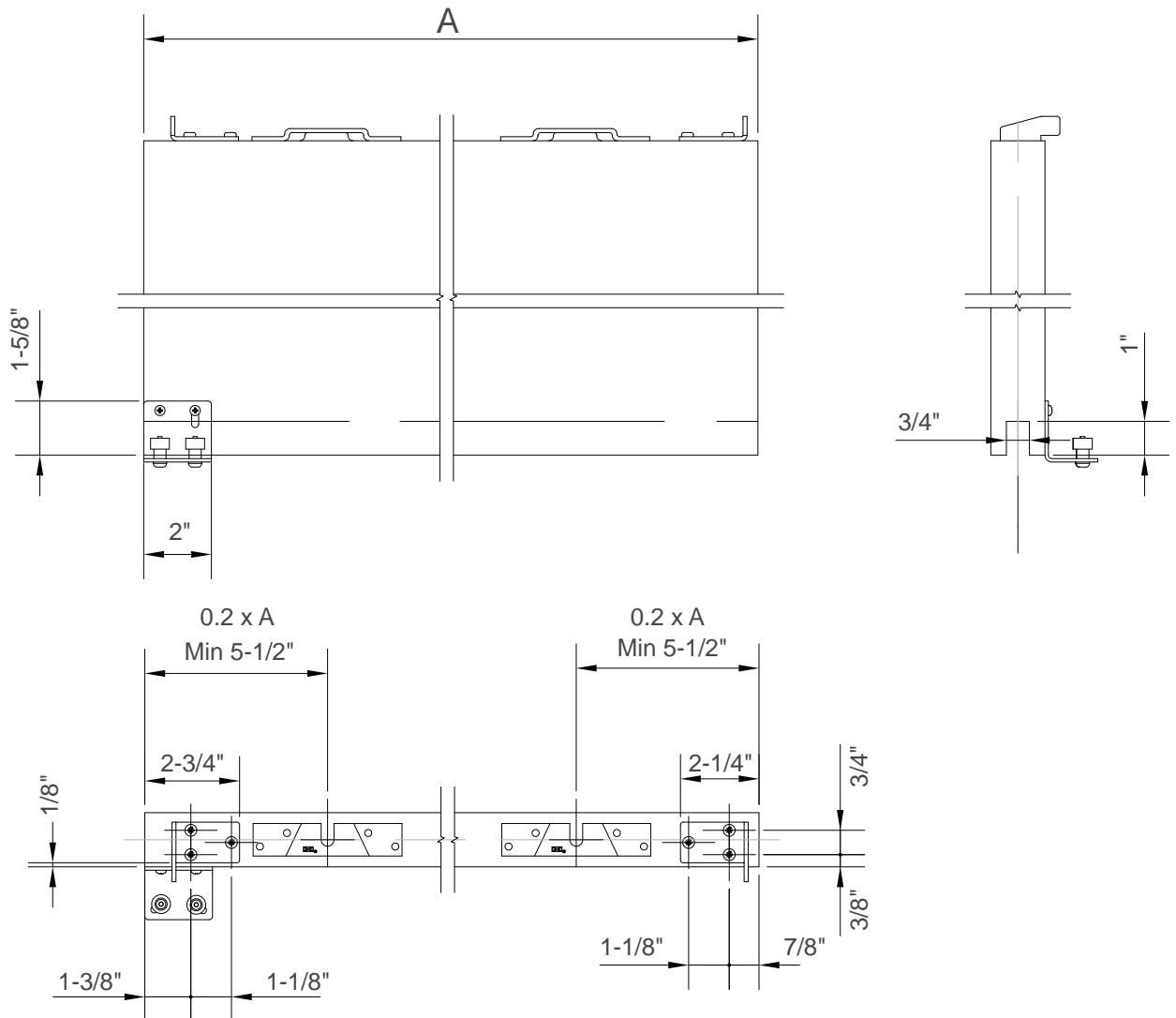



P2

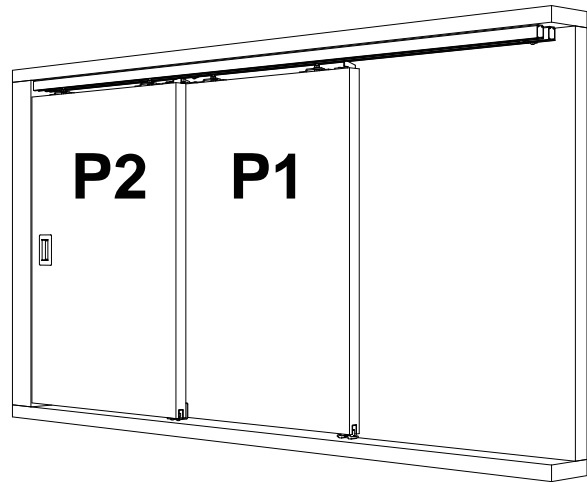

P2

