

x4

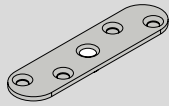

x4

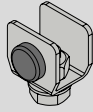

x4

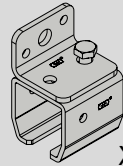

x7

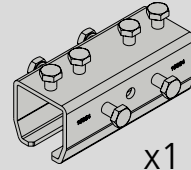

x1

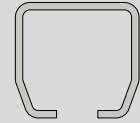

x2



180 lbs

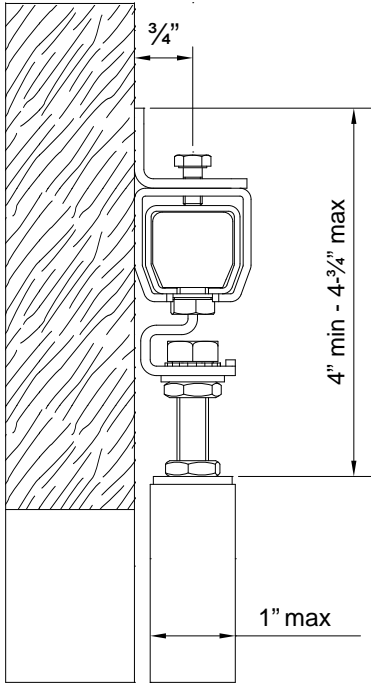

**1**

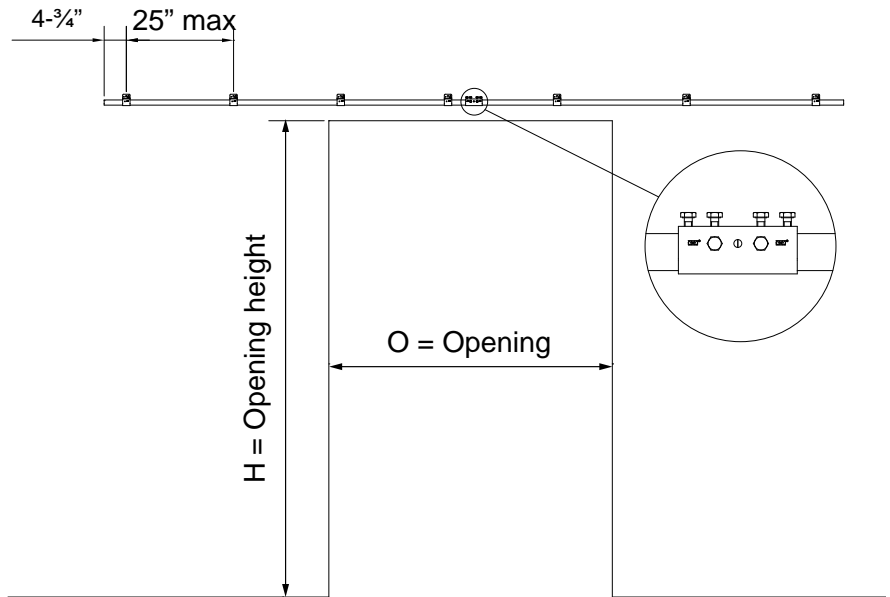

**2**

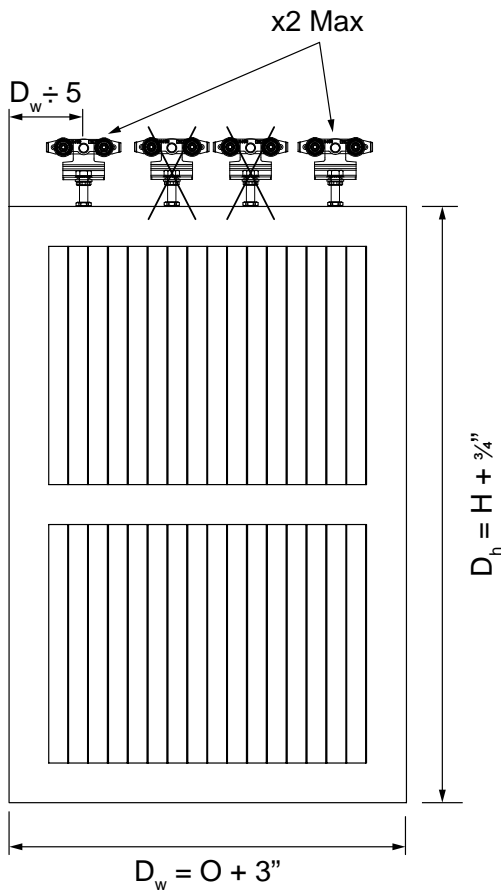

**3**

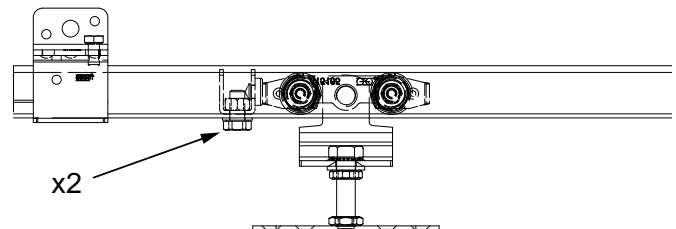

**4** OPTION :

