

x4

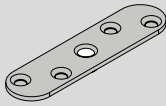

x4

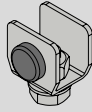

x4

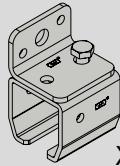

x7

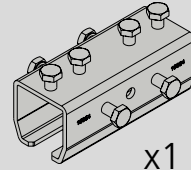

x1

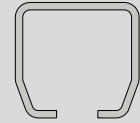

x2



130 lbs

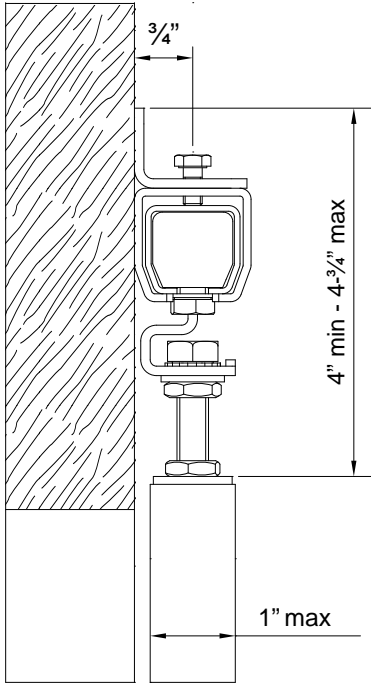

1

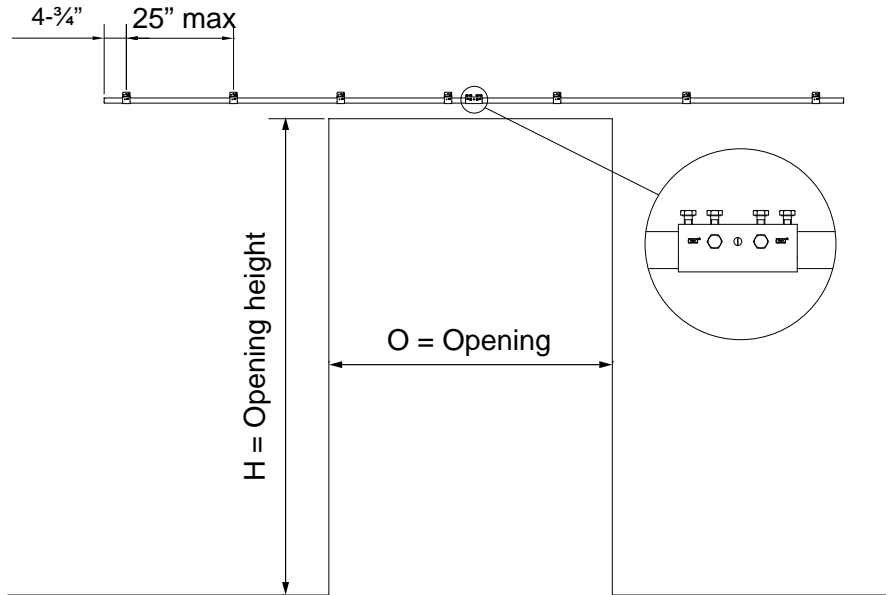

2

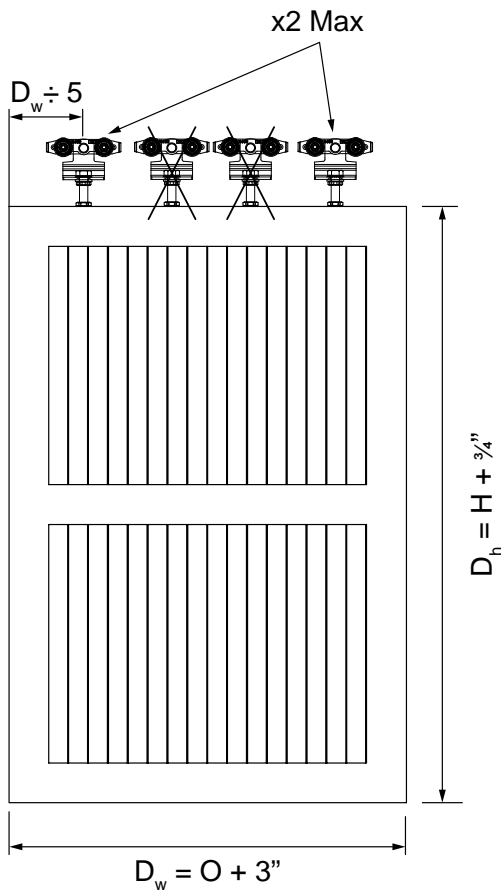

3

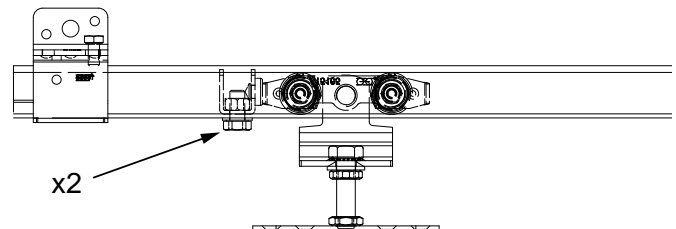

4 OPTION :

