



x1



x1



x2

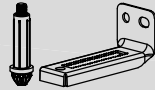

x2

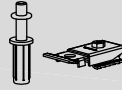

x2

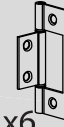

x6



14KG  
30lb

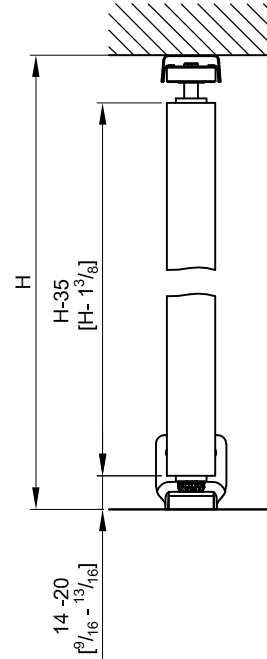
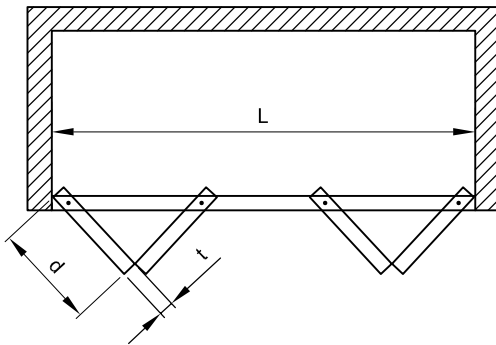

t [mm]	<28	28 ÷ 30	31 ÷ 38
x [mm]	0	2	4
t [in]	<1 <sup>1</sup> / <sub>8</sub>	1 <sup>1</sup> / <sub>8</sub> ÷ 1 <sup>1</sup> / <sub>4</sub>	
x [in]	1 <sup>1</sup> / <sub>16</sub>	1 <sup>1</sup> / <sub>8</sub>	

$$d = (L/4 - 3) - x$$

$$[d = (\frac{L}{4} - \frac{1}{8}) - x]$$

**1**

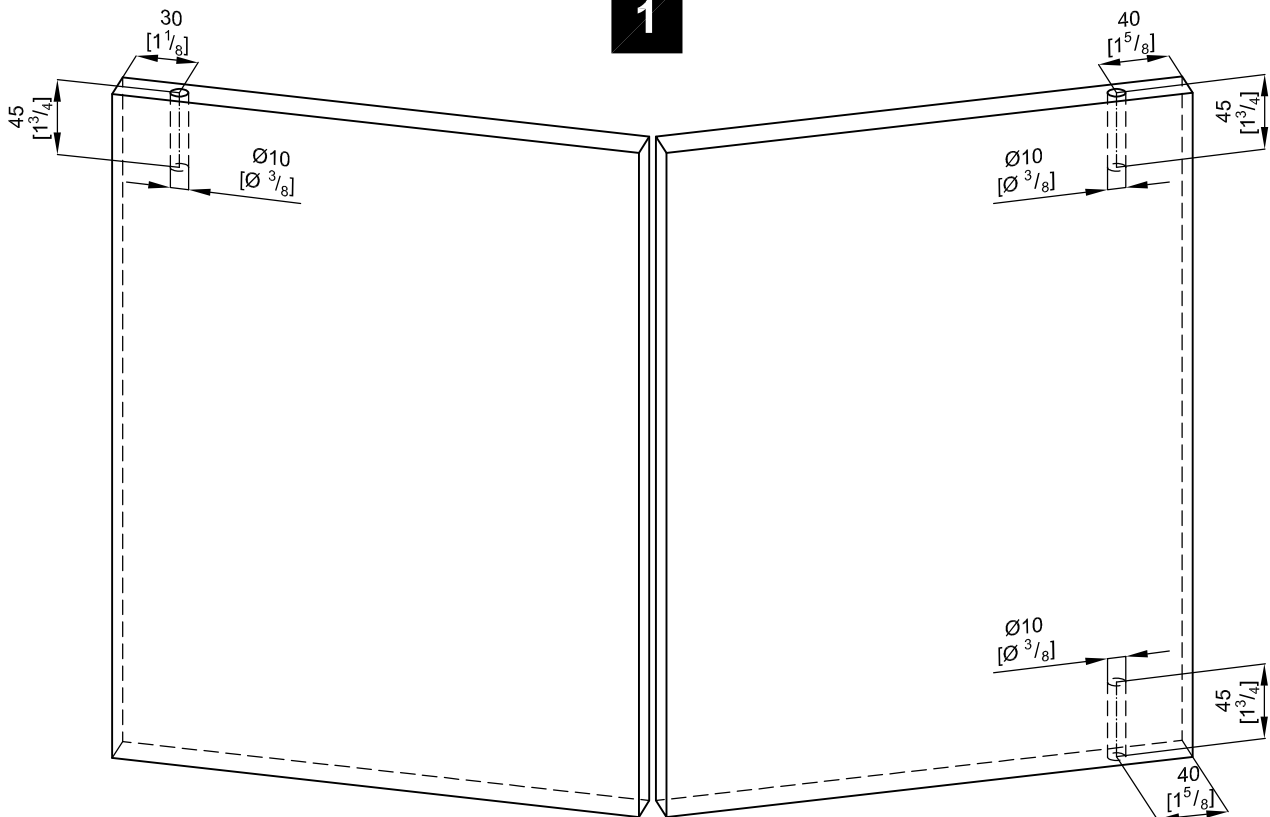

2

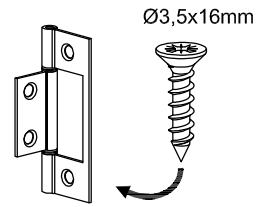
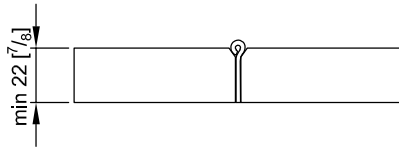
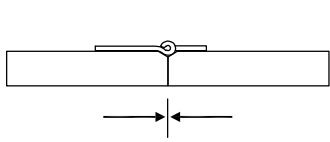

3

