



x1



x1



x1

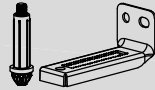

x1

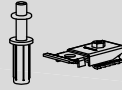

x1

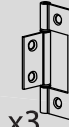

x3



14KG  
30lb

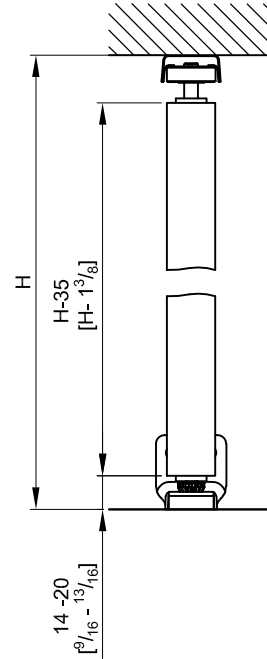
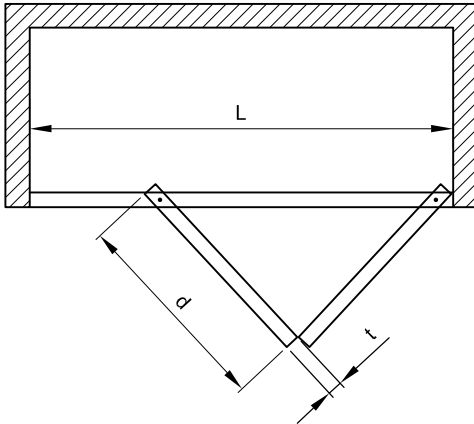

t [mm]	<28	28 ÷ 30	31 ÷ 38
x [mm]	0	2	4
t [in]	<1 1/8	1 1/8 ÷ 1 1/4	
x [in]	1/16	1/8	

$$d = (L/2 - 4) - x$$

$$[d = (\frac{L}{2} - \frac{3}{16}) - x]$$

**1**

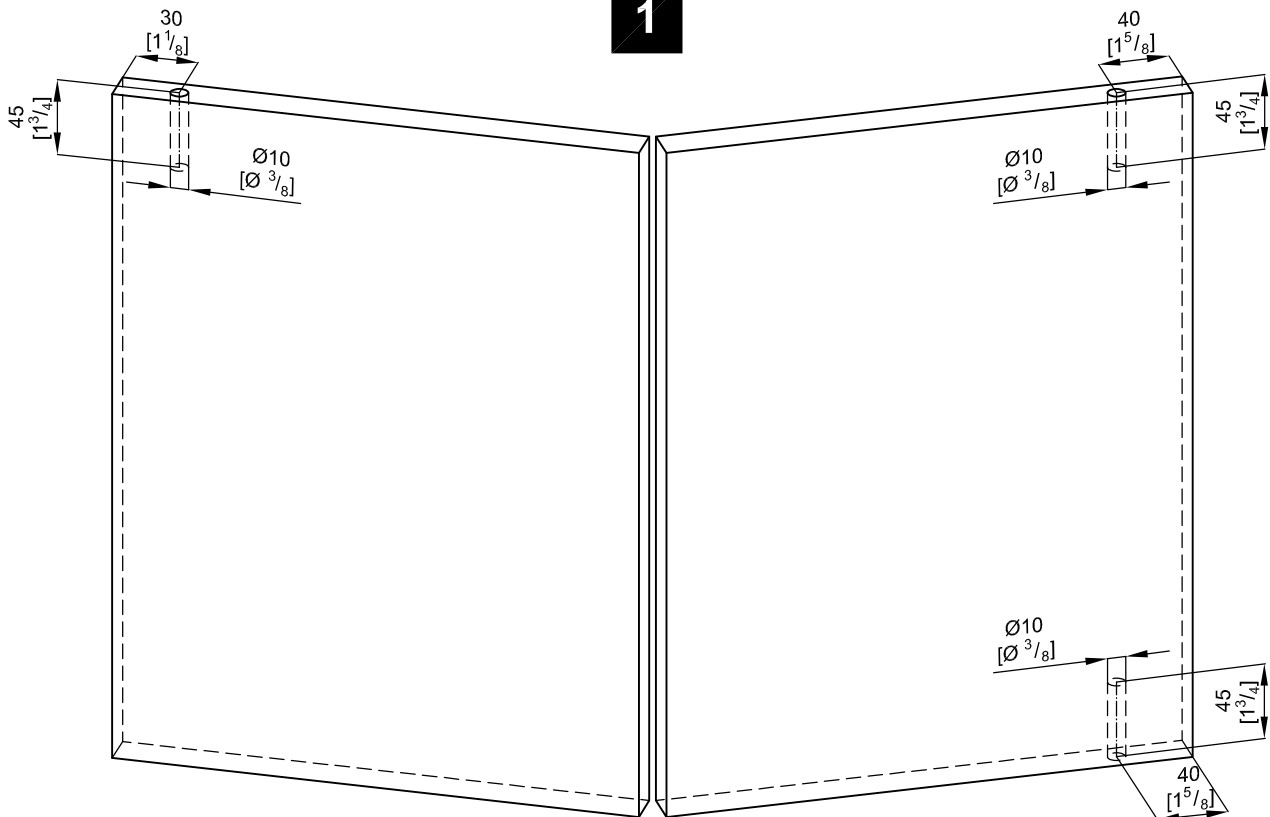

**2**

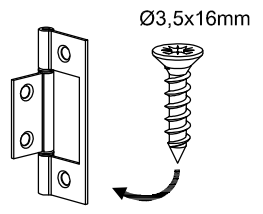
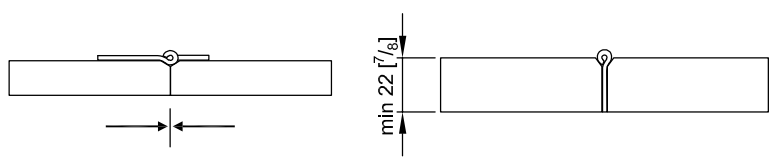

**3**

