

x2

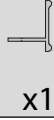

x1



x2



x2



x1

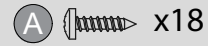

x18

50 kg

1

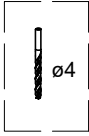

ø4

$nx \ \varnothing 4$

2

1

D [mm]	<500	≥500
n	2	3

x2

70

D-58

h+8

70



x2

2

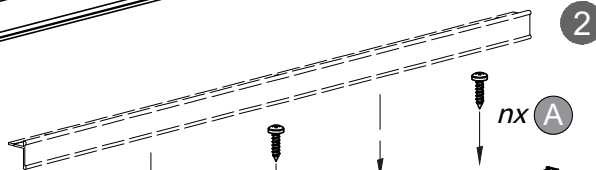

2

$nx \ A$

3

1

1

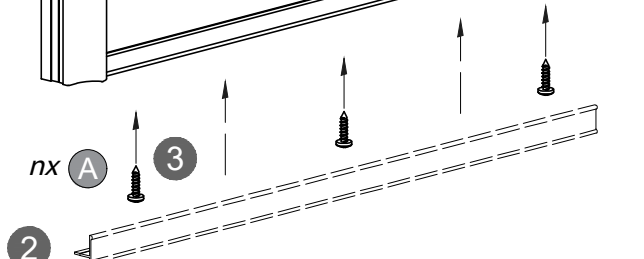
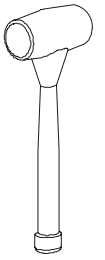
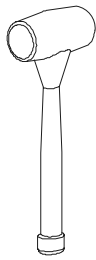

$nx \ A$

3

2



3

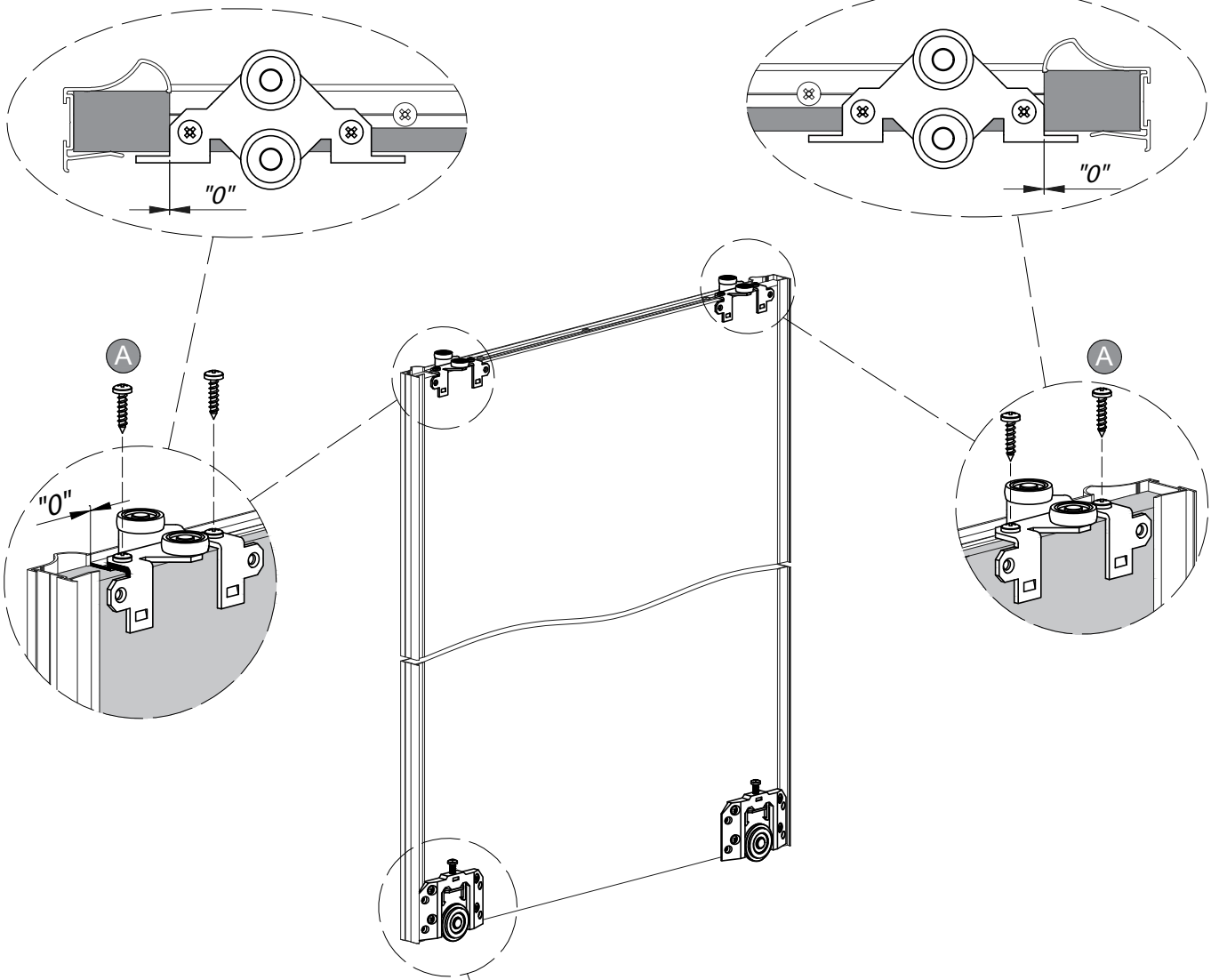

4

